

Technical data sheet

Spacer clip 732 G

Item number: 1362417



Spacer clip for the installation of pipes and cables on walls, ceilings and floors. With self-locking cover. Fastening via attachment piece with internal thread.

Approved for the maintenance of electrical function according to DIN 4102 Part 12, maintenance of electrical function classes E 30 to E 90.



St Steel

G Electrogalvanized

Master data

Item number	1362417
Type	ASG 732 17 G
Description 1	Distance saddle
Description 2	with threaded connection M6
Manufacturer	OBO
Dimension	14-17mm
Material	Steel
Surface	Electrogalvanized
Surface standard	EN ISO 19598 / EN ISO 4042
Smallest sales unit	25
Unit of quantity	Piece
Weight	1.793 kg
Weight unit	kg/100 pc.

Technical data sheet

Spacer clip 732 G

Item number: 1362417



Dimensions

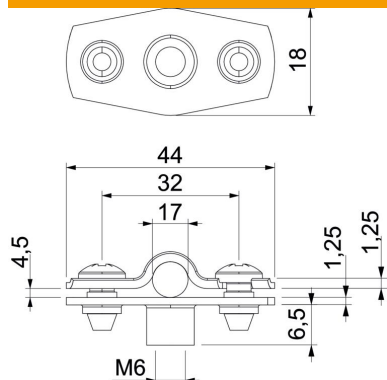

Dimension A	44 mm
Dimension B	32 mm
Dimension b	18 mm
Dimension D	17 mm
Dimension d max.	17 mm
Dimension d min.	14 mm
Dimension H1	6.5 mm
Dimension t1 (mm)	1.25
Dimension t2 (mm)	1.25
Dimension x	4.5 mm

Technical data

Distance to the wall	yes
Number of cables/pipes	1
Version for	Closed
Fastening type	Threaded connection
For diameter	14 - 17
Suitable in fire protection area	yes
Halogen-free	yes
Plastic-covered	no
Material thickness	1.25 mm
Clamping range D, max.	17 mm
Clamping range D, min.	14 mm
UV-resistant	yes